

ULTRASEALTM WORLD'S #1 TIRE SEALANT



**PREVENT-A-FLAT[®]
EXTENDS TIRE LIFE[®]
WE FIX FLATS BEFORE THEY HAPPEN[®]**

TECHNICAL MANUAL



Ultraseal International, Inc.

TABLE OF CONTENTS

<p>WHAT IS ULTRASEAL TIRE LIFE EXTENDER/sealer™</p> <ul style="list-style-type: none"> • A Tire Preservative & Longevity Enhancer • Description • Sealing Capabilities • Coating and Conditioning • Stands on guard • Permanent repair • What is rubber recovery • What is tire flexing • Ultraseal will not cure inside the tire 	1-2
<p>INSTALLATION EQUIPMENT</p> <ul style="list-style-type: none"> • Manual pump kit • Pump maintenance and repair • Automatic air pump kit • Valve Core Remover (VCR) • Dual wheel tool kit • Large bore tool kit 	3-5
<p>ULTRASEAL INSTALLATION</p> <ul style="list-style-type: none"> • Procedures • Equipment with dual wheels • Equipment with large bore valves • With Quick Chuck • Installation amounts 	6-9
<p>INSTALLATION TIPS</p> <ul style="list-style-type: none"> • Tires or tubes with long valve cores • Split rims - Dangerous killers • Zippers, the radial tire phenomenon • Tubes • Do not use Ultraseal to repair tubes • Using Ultraseal to repair a flat (tubeless tire) • Unable to push pump handle down • Valve core recommendations • Valve core won't unscrew • Air source requirements • Clearing the valve core • Checking air pressure • Tire balance • Re-balancing tire <small>(containing Ultraseal)</small> 	9-12
<p>MAINTENANCE REQUIREMENTS</p> <ul style="list-style-type: none"> • Air pressure check • Tube type tires • Tubeless tires 	12-13
<p>PROBLEMS AND REMEDIES</p> <p>Unable to hold air pressure</p> <ul style="list-style-type: none"> • Only air is escaping • Air and Ultraseal are bleeding • Air loss due to porosity • Sidewall puncture • Major damage <p>Unable to add air to the tire</p> <ul style="list-style-type: none"> • Valve core blockage <p>How to repair a tire containing Ultraseal</p> <ul style="list-style-type: none"> • Tubeless tires • Tube type tires 	13-14
<p>Retreading tires containing Ultraseal</p> <ul style="list-style-type: none"> • Preparing the tire for retreading • Tire inspection • Retread compatibility 	14
<p>INFORMATIVE DIAGRAMS</p>	15

The entire contents of this document may not be reproduced or quoted in whole or in part by mimeograph or other printed means without written permission from Ultraseal International, Inc. Trademarks, Copyrights & Tradenames are the sole ownership of Ultraseal International, Inc.

WHAT IS ULTRASEAL TIRE LIFE EXTENDER/ sealer™ ?

• A TIRE PRESERVATIVE & LONGEVITY ENHANCER!

Through Ultraseal International, Inc.'s extensive research and development efforts, our proprietary formulation has progressed far beyond the parameters of what is commonly known as a tire sealant. Our chemists have developed an unrivaled concept: **a preservative for increasing tire longevity and safety**. Ultraseal will convert any pneumatic tire into a self-sealing tire that will maintain air pressure and coat the entire inner surface of a spinning tire without succumbing to the shear and stress, associated with centrifugal force created within a rotating tire. Ultraseal's attributes are unparalleled in the history of the pneumatic tire.

• DESCRIPTION

Once Ultraseal has been installed, it will lay dormant at the bottom of the tire until the vehicle is driven. Once driven a minimum of three to five miles, Ultraseal disperses throughout the inner air cavity and forms a coating on the entire inner surface of the tire/wheel. The flexing of the tire and the normal heat buildup will allow Ultraseal to seek out and eliminate common air loss problems (referred to as air migration and bead leaks). Ultraseal then transforms the tire/wheel into a sealed air chamber, capable of maintaining proper air pressure. Thereafter, Ultraseal conditions the rubber in order to retard dry rot and hardening of the casing. One treatment will provide additional longevity and cooler running tires.

The advanced technological sealing capabilities of Ultraseal stand on guard, to seal punctures as they occur. When a tire is punctured, Ultraseal coats the surface of the penetrating object thus preventing air loss. When the puncturing object is removed, the rubber recovers and the wound immediately closes. Any escaping air will siphon Ultraseal into the wound. The fibers begin to entwine and create a clot to prevent any additional air from escaping. As the rubber recovers, the wound closes and the strength of the tire holds the repair in place. The specialized polymers and fibers form a clot, producing an airtight repair. The small amount of Ultraseal that penetrates through the wound, past the belts and out through the tread area is referred to as a repair/clot. Once exposed to the atmosphere, the repair/clot begins a systematic chemical cure (another proprietary attribute from the Ultraseal R&D Team). As the repair/clot cures, it makes a permanent repair that is impervious to water, which totally protects the belts and inner casing from outside contaminants and corrosion.

Ultraseal's formulation contains Thixogel[®], one of our closely guarded secrets that allows Ultraseal to withstand heat and the shear forces created within a rotating tire. The thixotropic emulsion stretches and recovers under mild to severe exposure of the adverse forces and continuously clings to the inner surface of the tire/wheel. The ability to evenly coat the inner surface against adverse conditions and centrifugal force is the reason that Ultraseal Tire Life Extender/sealer™ will not adversely effect a balanced tire/wheel and will not lose the ability to provide protection for the tread life of the tire. Ultraseal's operating temperatures under normal conditions range from -40°F to +302°F.

• SEALING CAPABILITIES

Ultraseal International, Inc. manufactures two grades of Ultraseal Tire Life Extender/sealer.™

1. Commercial/Industrial grade - is formulated for any vehicle with pneumatic tires, tube or tubeless, high or low air pressure and used in highway speed vehicles or slow off road equipment tires. This formula will seal wounds caused by puncturing objects **up to 1/4" in diameter**. Ultraseal is designed to bleed and slowly release air pressure, if the wound has damaged the inner structure and the tire has been rendered unsafe. Ultraseal will not hide or mask a dangerous wound regardless of how small it may be.

2. Heavy Duty 'XHD' grade - is formulated for Military combat vehicles, armored vehicles and off road equipment. Used in combat vehicle tires where bullet wounds would prevent any vehicle from completing its mission, Ultraseal is capable of sealing large wounds, allowing the vehicle to remain mobile. Once again, Ultraseal provides that extra reliability and very important uptime on mining and construction equipment, where downtime is extremely costly. XHD grade is not designed for regular passenger vehicles. It will seal wounds caused by puncturing objects **up to 1/2" in diameter**.

• COATING AND CONDITIONING

It is imperative that the proper amount of Ultraseal be installed in a tire (see application chart) and the vehicle driven approximately 3 to 5 miles (it is not required to immediately drive the vehicle), Ultraseal coats and clings to the tire's entire inner air cavity, conditioning the inner surface, eliminating porosity and bead leaks. Thixogel[®] prevents Ultraseal from migrating to the tread area at high speeds.

AIR MIGRATION are the multitude of porous passage ways that allow air to penetrate and migrate through the tire's inner structure. It is next to impossible to produce a new or retreaded tire without some air migration existing. As the vehicle is driven, tire temperature increases, the air inside the tire expands and air bubbles are forced into the porous passage ways. Once the air bubbles migrate into the inner structure they will continue to expand from heat. If the migrating air can not escape through the tire's various plies and into the atmosphere, it will eventually cause tread separation and/or a bubble on the sidewall. If the migrating air does escape the tire is left underinflated, either way, premature tire failure is inevitable. Underinflation is the #1 cause of Zipper ruptures (blowouts).

• **STANDS ON GUARD**

Once the initial driving/usage period has been attained, Ultraseal will be thoroughly distributed throughout the entire inner surface of the tire/wheel. Ultraseal is a proprietary liquid coating that will continuously stand on guard to protect tires against air loss for the legal tread life of the tire.

• **PERMANENT REPAIR (safe secure repair)**

When a tire is punctured, Ultraseal is forced against and around the puncturing object by the inner air pressure, thereby preventing air from escaping. If the puncturing object is thrown out of the tire by centrifugal force or is pulled out, the inside air forces Ultraseal into the wound and immediately stops air loss. Special fibers entwine, forming a clot, then as the rubber recovers (see rubber recovery), aided by the flexing as the tire rotates, the inner air pressure will force the repair/clot well into and through the wound. Once Ultraseal is exposed to the outside air, a chemical curing process begins. The cured repair/clot extends well into the wound, thus providing a repair that is impervious to water (rain, snow, mud, etc.). As this repair/clot cures, it is transposed into a permanent rubberized seal, protecting the inner casing and steel belts against contaminants entering the wound.

• **WHAT IS RUBBER RECOVERY?**

Rubber recovery within a tire, is very important in conjunction with Ultraseal. When a tire is punctured, the rubber is forced open by the penetrating object. The wound is actually much smaller than the puncturing object. Rubber has memory and it will recover to its previous shape after being subjected to adverse conditions or stress factors. When the penetrating object is removed, the rubber recovers and the wound closes (a tire that is old, worn out and/or dry rotted will have little or no rubber recovery). A penetrating object left in a tire for any extended period of time causes the rubber to temporarily lose its ability to recover. After removing the puncturing object, it is recommended to immediately flex the tire to reactivate the rubber's memory. As the wound closes, Ultraseal will be held in place and will create a permanent repair/clot.

• **WHAT IS TIRE FLEXING?**

Tires are constantly flexing when a vehicle is driven. The weight of the vehicle, the irregular surface of the road, and the turning of the tires create a substantial amount of flexing. It is important for the Ultraseal repair/clot to be forced into and through a wound. Once this is accomplished the repair/clot cures and becomes a permanent seal. Manual tire flexing can be accomplished by striking the tire repeatedly with a mallet around the wound area and/or bouncing the tire against the ground. This method creates a temporary repair that will become permanent once the tire is installed onto the vehicle and is returned to service or driven approximately 3 to 5 miles.

• **ULTRASEAL WILL NOT CURE OR HARDEN INSIDE OF THE TIRE**

People often ask "If Ultraseal cures from exposure to outside air, then why doesn't it cure by the air inside of the tire?" As the vehicle is driven and the temperature of the tire increases, a portion of the liquid base evaporates within the tire's inner air cavity, as the tire cools, the liquid condensates back into the formula. The inside air actually becomes part of the system. The sealed air chamber prevents outside air from entering or inside air from escaping. Constant air pressure resettings are not required. Tires and air pressure should be inspected during routine Preventative Maintenance (PM) program.

INSTALLATION EQUIPMENT

• MANUAL PUMP KIT (includes VCR) Part #....3610-46-HP

The heavy duty aluminum positive displacement pump is calibrated in unit increments (1 unit = 1 oz.), it can be set to dispense one to four units per stroke. This pump can be used to service a tire containing up to 125 lbs of air pressure. A special patented collar secures the pump to the pail. The collar contains a return spout, which is used to relieve pressure and to connect the hose during storage. This connection assures that the hose, Quick Chuck, and the VCR will be airtight so that Ultraseal will not cure. This will reduce the need to clean the tools prior to each application. If the VCR or the Quick Chuck is not connected to the return spout, the Ultraseal residue will cure, but it is easy to clean. Simply rinse with water and blow clear with air. A thin wire is also useful to help clear any clogged passages. Make sure to check the return spout; if clogged, clear with the wire.

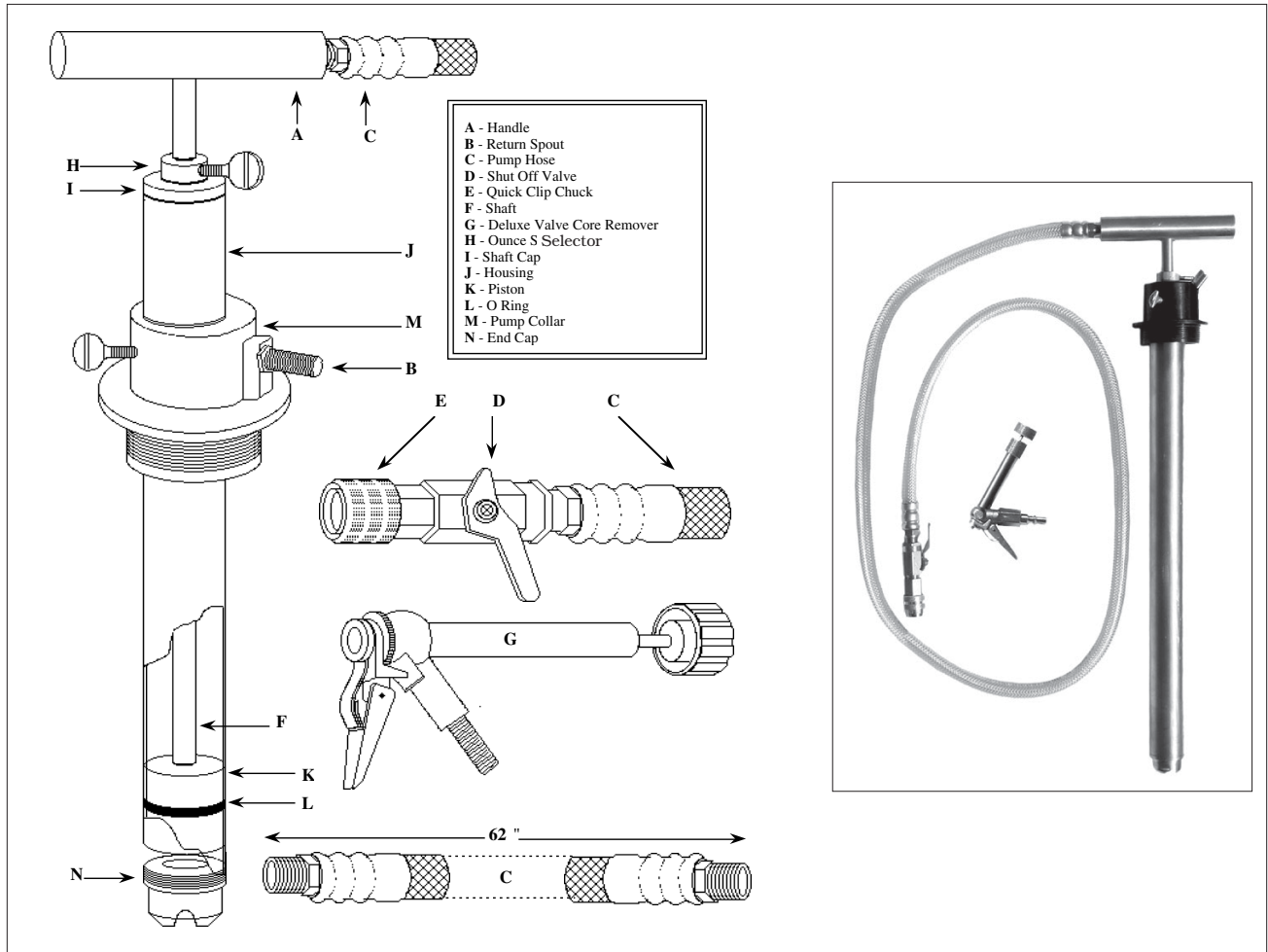

• PUMP MAINTENANCE AND REPAIR

When the pail is empty and prior to transferring the pump into a new pail, we recommend that the pump be flushed with water. Ultraseal fibers can collect at the bottom of the pump and create a blockage, which will eventually prevent the pump from operating. This blockage will sometimes pass through the pump and jam the valve stem or VCR. Flushing the pump will prevent the majority of clogging problems. The procedure is simple; remove the pump from pail and place it into a bucket of water. Pump the handle up and down several times. Then remove the pump from the water and continue to pump until the pump is completely drained of water. The accessory tools such as the VCR and the Dual Wheel Tools should be flushed after each use. Ultraseal pumps can be completely dismantled for servicing.

• AUTOMATIC AIR OPERATED PUMP KIT (Part # 900-46)

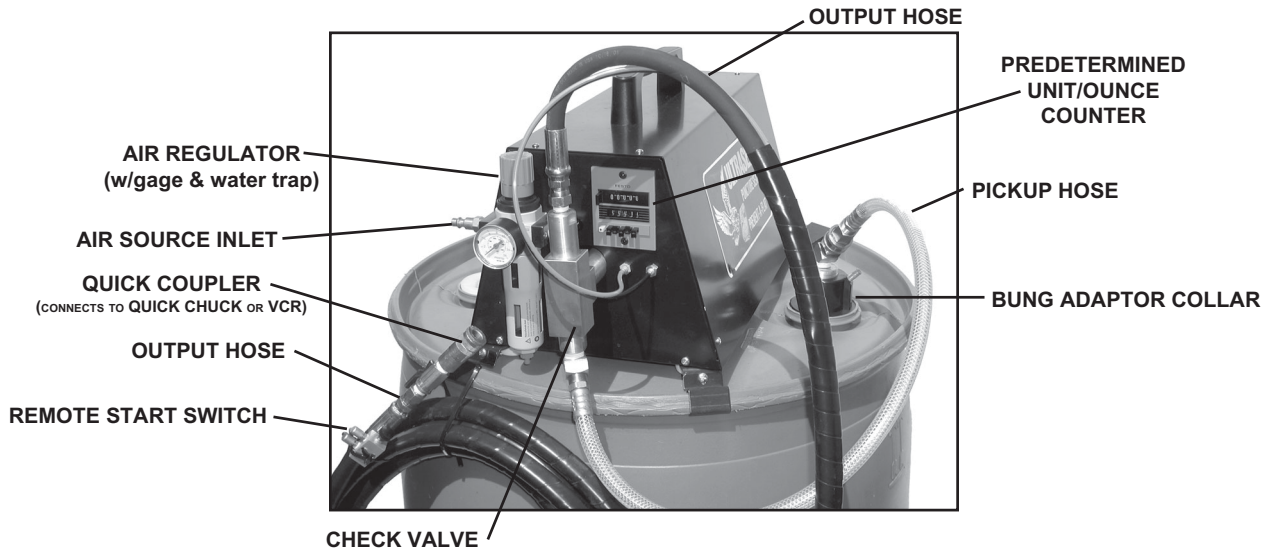

PRIMING THE PUMP

Prior to using a new pump or exchanging an empty drum, it is necessary to prime the pump. Attach the output hose (with quick chuck attached) to the pump/adaptor collar's return spout (screwed into the drum bung). Open the shut-off valve at the end of the output hose (turn lever to the open position, which is in-line with the hose). It is important to crack open (approximately 2 to 3 turns) the second bung on the top of the drum, thereby allowing the drum to vent.

Set the predetermined counter to 100 ounces/units then press the start switch at the end of the output hose. The pump will begin cycling. Within 30 seconds you will see Ultraseal passing through the clear input hose, then through the output hose and recycle back into the drum. The pump will automatically stop when the selected amount has been reached. The pump is now primed. Turn shut-off valve's lever to the closed position (90°).

INSTALLING ULTRASEAL

Review the application charts for the specific amount of Ultraseal required for the tires that are to be treated. Set predetermined counter to the desired ounces/units.

Remove the valve core; using either the **(a)** Manual Method (preferred on large trucks and industrial equipment) or **(b)** Deluxe Valve Core Remover tool VCR (for automobiles and light trucks):

a) When manually removing core: Remove valve core with manual core remover, (a small amount of air pressure will be released), then push the quick chuck onto the valve stem. Make certain the connection is secure. With practice, only a small amount of air will be lost.

b) When using the VCR, attach the tool to the quick chuck on the output hose, then clip onto the tire's valve stem, remove the core as described in the installation procedures (in this manual). The air pressure will remain in the tire.

Open the shut-off valve (lever in-line with hose). Push the start switch. The pump will begin cycling. The counter will progress as Ultraseal is being pumped into the tire. When the desired amount is reached the pump will automatically stop and reset. Close the shut-off valve, reinstall valve core, remove tool/hose from tire.

ROUTINE MAINTENANCE

Flushing the pump and hose assembly after daily use is recommended, especially if the pump is removed from service for more than two days. Set the counter to 100 ounces/units and release the suction hose from the quick disconnect coupler from the pickup tube. Connect the output hose to the return spout on the bung adapter. Open the shut-off valve and press the start switch. This will expel all of the Ultraseal from the system and into the drum. Next, Set a small water bucket next to the drum and drop in the ends of the input and output hoses, press the start switch. This will flush the system. Finally, remove the input hose from the water and press the start switch. This will purge the water from the system. Reconnect the input hose, roll up the output hose and disconnect the air source. Pump will need re-priming when returned to service.

CLEARING RESTRICTIONS IN OUTPUT HOSE

Attach output hose/quick chuck to Adapter Collar's return spout and start pump. This allows the system to work without back pressure clearing any restrictions.

CLEANING THE PUMP CHECK VALVE

Remove the input and output hoses from the check valve housing. Loosen the two Barrels (which have been machined with wrench flats to facilitate dismantling) that are attached to the top and bottom of the check valve housing using a 7/8" wrench. There is one stainless steel ball resting in the top of the housing and one resting in the top of the lower barrel. Carefully remove the lower barrel to avoid dropping the ball. The upper ball may be pushed up and out of the housing from the bottom using the flat end of a pencil or wooden dowel (do not use metal objects). Metal objects may damage the barrels. Clear any remaining residue with a small blast of air or water. This will clear any restriction that may have developed. Carefully reassemble the check valve (do not over tighten). Reprime pump.

NOTE: This is an infrequent procedure and is only required if "Routine Maintenance" is not performed as recommended.



• VALVE CORE REMOVER (VCR) - Part #G-3646

This specially designed patented tool is indispensable when servicing fleets. The ability to install Ultraseal without having to let the air out of the tire saves a tremendous amount of labor and equipment downtime. An average passenger car or light truck tire can be serviced in less than two minutes and a large truck tire can be serviced in less than five minutes, wherever the vehicle may be located. The VCR quickly connects to the Quick Chuck on the end of the hose. To remove the valve core, place the VCR onto the valve stem, push the knob/shaft downwards, when it is aligned, additional downward action will snap and lock it onto the valve core. Unscrew the core, when completely unscrewed it will slip back into the air tight chamber (the tire will not lose air pressure during installation), this clears the valve stem passage for the installation of Ultraseal. After installing the required amount, push the knob/shaft down and reinsert the valve core into the valve stem and tighten. No air is lost during this procedure and it is accomplished very quickly.

• DUAL WHEEL APPLICATION TOOL KIT - Part #555 (4 pcs)

This kit is for standard bore valves and valve cores consisting of a specially designed extended valve core extractor, an extended straight-on self locking air chuck, a short standard bore valve core extractor and an extended 180° self locking air chuck. Utilizing these tools will require the loss of a few pounds of air. However, the installation is quickly accomplished.



For the inside dual wheel: Extended straight-on self locking air chuck



For the outside dual wheel: Extended 180° self locking air chuck.



Short valve core remover for outside rear wheel

• DUAL WHEEL/LARGE BORE KIT - Part #655 (5 pcs) (Includes above kit #555)

Ultraseal has two methods of application regarding equipment with large bore valves.

The Large Bore application tool (part # LB-200) attaches to the standard Quick Chuck (on the end of the pump hose). After manually removing the valve core, attach the tool directly onto the valve stem, proceed with the Ultraseal installation, then manually replace the valve core and re-air the tire.



Part # LB-200

ULTRASEAL INSTALLATION

• PROCEDURES

Ultraseal is applied through the tire's valve stem with a specially designed air tight valve core removing tool, the deluxe "Valve Core Remover" (VCR) allows for the installation of Ultraseal without the necessity to deflate the tires. Using the VCR has tremendous advantages, any vehicle can be serviced wherever it may be, it is not necessary to take the equipment into the garage for servicing. Installation requires approximately two minutes per average passenger car or light truck tire and 5 minutes for tires on large trucks and equipment. After installing Ultraseal always blow a slight amount of air into the tire to clear the valve core, prior to taking a pressure reading.



Squeeze the trigger and place the VCR onto the valve stem. Position of the tire is not critical.



"VERY IMPORTANT"
Push the plunger/knob down to engage the valve core. Slowly turn the knob, lining up on the valve core. **Press down to engage and lock onto the core.**

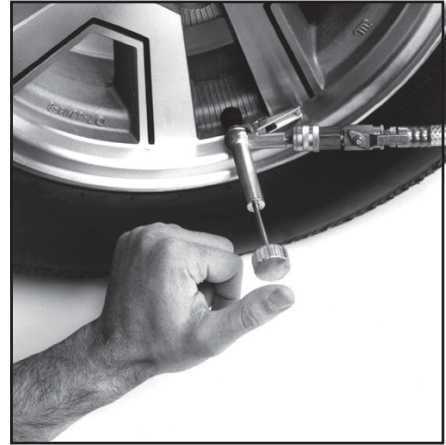

Put your thumb on top of the VCR's knob applying downward pressure. With the other hand, unscrew the knob (about 25 revolutions) or until the core clicks.



Release the pressure from your thumb, thereby allowing the tire's air pressure to push the knob, shaft and valve core up into the chamber.

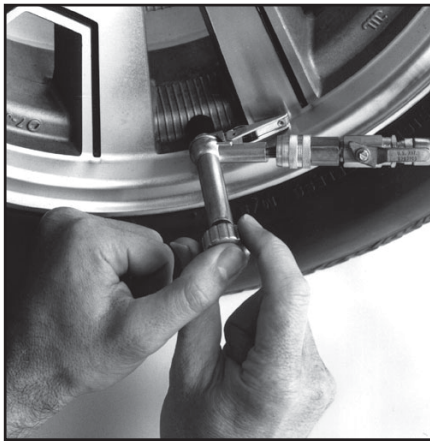

With the core stored up into the VCR chamber, Ultraseal can easily be installed without losing air pressure.

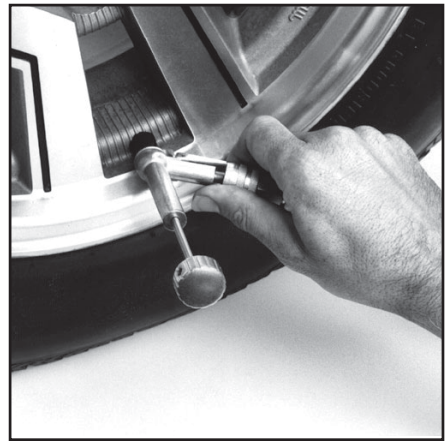

After installing Ultraseal, Put thumb on knob pushing core back down into the stem. Tighten until snug plus 1/4 turn to lock in place.

"Close Shut-off Valve"

VERY IMPORTANT - TECH TIP

As shown in figure 2 (above), Once the shaft has been aligned to the valve core, with your other hand, use your thumb to push down on the knob/shaft. Applying firm pressure will engage (down approx. 1/8") the locking shaft onto the valve core. As the shaft locks onto the valve core, you will feel and/or hear a definite snap.

The pump hose is equipped with a shut off valve and "Quick Chuck" onto which the VCR attaches. This "Quick Chuck" is used for installing Ultraseal while mounting tires or when tires are deflated (remove valve core prior to using the Quick Chuck). Simply push the Quick Chuck onto the valve stem (it is self locking), After installation of Ultraseal, pull knurled ring on the Quick Chuck back, to disengage. Special tools have been designed to service vehicles with dual wheels.

• INSTALLATION TECH TIPS

1. When utilizing the VCR, maintain constant thumb pressure on the knob until you are certain that the valve core is free of the stem (turn knob to the left, at least 25 to 30 revolutions).
2. If the pump does not operate freely, do not force the handle down. Check to make sure that the shut off valve is in the open position and/or the core may be hung up in the valve stem or VCR chamber and will prevent pumping. Tighten the valve core and restart the valve core removal procedure.
3. Check the application chart for the proper amount of Ultraseal to be installed, as per vehicle's mission profile. The pump shaft is calibrated in nine unit ounce increments, this allows for installing the exact amount required.
4. When installation is complete, reverse the procedure, by putting thumb pressure on the knob and pushing down to reinsert the valve core. Do not over tighten the core. When the core is snug, then, only tighten an additional 1/4 turn. This will lock the core in place. Pull up/out on the knob to free it from the core, turn the shut off valve to the OFF position and remove the VCR.
5. Always return the VCR/hose to the pail and reattach it to the return spout. Open the shut off valve, releasing the pressure and excess Ultraseal into the pail with the knob in the up position and the shut off valve in the open position, the unit is ready for the next installation.
6. Clean the valve stem/core outer surface by the following procedures; Blowing air through the valve, spraying with water or wiping clear with a rag and pointed object.
7. It is recommended to check and set air pressure one week after installation. This allows the Ultraseal to locate and eliminate the porosity during the interim. Once this is completed it should be necessary to check air pressures only during normal routine PM schedules.

It is not necessary, for tires that have been treated with Ultraseal to be immediately returned to service; they may be stored for future use. Ultraseal will not cure inside of a tire (sealed air chamber).

The Application Chart specifies the amount of Ultraseal required per tire size and tire usage (mission profile). Ultraseal Tire Life Extender/*sealer* is available in two distinctly different formulas:

The Industrial/Commercial grade is used in high speed vehicle tires and in all types and sizes of commercial equipment tires. The Application Chart specifies two separate application amounts per tire size. A specific size tire, when used on passenger or light truck type vehicles at highway speeds requires the amount indicated in the "Standard" column, whereas the same size tire if used on/off highway will require a different amount. If the same size tire is used for construction or other extreme exposure situations, use the amount specified in the "Off Road" column. The reason for installing different amounts is quite simple; in order to coat and penetrate (to eliminate porosity and preserve the casing) the entire inner surface of a tire and wheel (inner air cavity's total square inches) requires a specific amount of Ultraseal, plus a reserve is needed. The reserve provides additional protection for the tire, each time a tire receives a puncture, a small amount of Ultraseal is used. Vehicles or equipment being used off road will sustain many additional punctures during its lifetime, therefore additional reserve is required. **The "XHD" grade** is for commercial off road equipment, military combat vehicles and law enforcement SWAT teams where tires are exposed to severe service and may experience large punctures.

• INSTALLATION ON EQUIPMENT WITH DUAL WHEELS

For most vehicles equipped with dual wheels, it is impossible to attach the VCR onto the outer tire since the valve stem is pointed inward and the inner tire's valve stem is recessed much too far for the VCR to reach. Air supply tools have been redesigned and modified by Ultraseal Engineers in order to easily install Ultraseal for vehicles with dual wheels. The application is quite simple and can be used on any hard to reach valve stem. The Dual Wheel application service kit contains; a long valve core extractor and a lock-on extension that attaches straight onto the inner tire's recessed valve stem. For the outer tire, where the valve stem points inward, a short valve core extractor is supplied with a 180° lock-on extension.

Inner tire - attach the straight lock-on extension to the inner valve stem. Slide extended valve core extractor into the straight lock-on extension. When it comes in contact with the valve core, align and snap onto core (see VCR

instructions), remove valve core and extractor, this begins to release air, quickly attach the Quick Chuck/hose to the extension tool and install Ultraseal. After installation turn shut off valve to off, remove Quick Chuck/hose and reinsert extractor and valve core (tighten as per VCR instructions), remove tools and reset air pressure.

Outer tire - manually remove the valve core, this begins to release air, attach the 180° tool (which has been previously connected to the Quick Chuck/hose) onto the valve stem. Install the required amount of Ultraseal, turn shut off valve to off, remove the 180° tool from the valve stem, manually replace the valve core and reset air pressure. After completing the application, flush the tools with water or blow out with air pressure to assure that the inside is clear of Ultraseal residue. Prior to taking an air pressure reading (see installation tips), always blow a slight amount of air into the tire to clear the valve core.

An alternative procedure to service dual wheeled vehicles in the shop, is to run the equipment's rear inner tires onto blocks. This will leave the outer rear tires free. Remove the outer tires, laying them down with the valve stem pointing up. The VCR can be used to service both the inner and outer tires with Ultraseal. Reinstall the outer rear tires, service the front tires and drive off the blocks. This procedure will eliminate the need to jack the equipment up. **Set the brakes and block all tires.**

• INSTALLATION EQUIPMENT FOR LARGE BORE VALVES

Ultraseal has two methods of application regarding equipment with large bore valves (see Installation Equipment section). Attach the LB-200 tool to the Quick Chuck located on the end of the pump hose. Manually remove the valve core, releasing some of the tires air pressure. Attach the LB-200 tool to the valve stem and install the required amount of Ultraseal. Turn the shut off valve (located on the pump hose) to the off position, remove the LB-200 tool from the valve stem and replace the valve core. Reinflate the tire to proper air pressure. After completing the applications the LB-200 tool should be flushed with water or blown out with air pressure to assure the inside is clear of Ultraseal residue. An alternative is the LB-100, which is a valve core reducer. To install, remove the large bore valve core, screw the LB-100 onto the valve stem and your tires are now equipped with a standard size valve core. This valve core reducer allows the tire to be serviced with standard air fittings and gauges. The Ultraseal can now be installed with our conventional application tools.

• INSTALLATION WITH QUICK CHUCK

Some installations may be difficult to complete with the VCR due to the valve stems being inaccessible. This is the primary reason for the Quick Chuck, located at the end of the pump hose (connected to the hose with a shut off valve). The Quick Chuck fits over the valve stem, push down on it to make the connection. To release, pull the Quick Chuck's knurled outer ring back, releasing the locking mechanism.

The Quick Chuck is used for tires or tubes that are deflated and/or have the valve cores removed. It is not necessary to release all of the air pressure to install Ultraseal. Simply attach the Quick Chuck as soon as the valve core has been removed. Put a finger over the valve stem to prevent pressure from escaping during the interim of attaching the Quick Chuck onto the valve stem.

• INSTALLATION AMOUNTS

There are various application amounts listed with each tire size (with the exception of passenger type tires). The required amounts are determined by mission profile and exposure to which tires are subjected. Ultraseal's thixotropic formulation requires that a specific amount of Ultraseal be installed to effectively provide a sufficient coating in the total area of the tire/wheel inner surface. A small amount of Ultraseal is designed to absorb into the tire's inner structure, to protect and retard the aging of the casings. Each tire manufacturers' casings are different and the absorption rate may vary. Older tire casings will absorb more Ultraseal than new tires. It is impossible to prejudge all of the variables in the vast array of tires and the adverse conditions or situations to which the tires may be exposed to. Therefore some circumstances may require additional attention from the installer. Ultraseal is designed to extend tire life and protect against flats, **The formulation will not fail to perform if proper procedures are followed.** Foreign substances can ruin the formulation, such as water. Ultraseal is a balanced formula and the addition of water can prevent the product from performing properly. Contamination of grease or oil in the tire will prevent Ultraseal from clinging to the inner surface of the tire and will also prevent it from making a permanent repair. Heat is a major factor that causes premature tire failure.

Ultraseal is formulated to reduce and dissipate heat in normal tire exposure. When a tire is exposed to extreme heat for extended periods of time, not only will the tire eventually disintegrate, it will effect the performance of Ultraseal. To enhance Ultraseal's performance when exposed to **extended extreme** adverse heat and overloading (which increases the heat factor) situations, always increase the application amount of Ultraseal (at the time of the initial application) by 10% to 20%, this will allow additional protection against long term excessive heat exposure.

Highway speed vehicles always balance tires prior to installing Ultraseal

• INSTALLATION TIPS

TIRES OR TUBES FITTED WITH LONG (spring type) VALVE CORES

We recommend that spring type valve cores be discarded and replaced with short valve cores. If you use the long spring type cores, we recommend that you install Ultraseal manually with the Quick Chuck or dual wheel application service tools. The VCR is not designed for spring type cores.

SPLIT RIMS - CAN BE DANGEROUS KILLERS!!!

Caution must always be taken when using split rims which are infamous for maiming or killing many tire personnel. It is best to discontinue the use of all known dangerous style split rims as soon as possible. In the interim, if you are going to deflate tires to install Ultraseal, utilize all precautions recommended by tire/rim mfgs. and always use the tire cage when re-airing the tires. If you are going to install Ultraseal into inflated tires with problematic type split rims while mounted on the vehicle, we suggest using the "alternate installation method" (see Installation on equipment with dual wheels section).

ZIPPERS, the radial tire phenomenon

A "Zipper" is a circumferential sidewall rupture that occur in steel belted radial tires. The rupture normally occurs in the flex area of the sidewall, releasing a blast of air that has caused serious damage and/or injury. Underinflation causes sidewalls to become over stressed by excessive flexing and the tire temperature increases dramatically. The steel belts are being overflexed from underinflation and structurally the steel deteriorates. The deterioration accumulates each time the tire is run underinflated, causing irreversible degradation. Heat is an accompanying factor that increases to a point where rubber and various tire components will actually melt and/or delaminate. Eventually the tire self destructs. The premature tire failure can happen at any time and it could happen months after the tire had been run underinflated. The only known and proven preventative, is Ultraseal Tire Life Extender/*sealer*, preferably applied at the time the tires are new; thereby preventing most underinflation and air/moisture from migrating. This attribute has never been duplicated by any other tire additive/sealant (all Ultraseal testing is proven and documented).

TUBES

Tubes are **not considered one of man's most ingenious inventions**. In fact, the only reason tubes were invented was because tires and rims would not hold air. Even though the tubeless tire has been around for many years, there still remains a great deal of equipment out there that utilizes tubes. There are tire personnel that will insert a tube into any tire that will not hold air pressure, this idea is only a temporarily stop gap, not a true solution. A tube's thickness, strength, elasticity and reliability is unpredictable. If your equipment should require tubes in the tires, be sure to use radial tubes. The initial cost may be slightly more, however the savings and reliability is greatly increased.

By installing Ultraseal into a tube, the problem can be reduced as Ultraseal will act as a puncture sealer at a cost less than that of a tube. Tubes squirm inside of a tire at higher speeds, if the puncturing object is left in, it may rip the tube, then even Ultraseal can not help. We recommend that nails be removed on a routine basis and the tire's air pressure maintained at maximum tire PSI (recommended by tire mfg.) to reduce tube squirming.

WE DO NOT RECOMMEND ULTRASEAL TO 'REPAIR DAMAGED TUBES'

It is impossible to know how badly the tube may be damaged in a tire that has been run flat. Since Ultraseal International, Inc.'s inception in 1969, experienced tiremen have stated that Ultraseal has eliminated approximately 75% of their flats in tube-type tires. Tubes are extremely unpredictable. A small puncturing object may cut a tube far beyond Ultraseal's ability to seal. A tube squirms inside of a tire that is used on a high speed vehicle (35 mph and up). The squirming action may cause a puncturing object to rip the tube. To obtain a 75% reliability factor, it is recommended that a tire inspection program be established, to remove the puncturing objects and immediately drive the vehicle, assuring that Ultraseal's clot/repair is forced well into the wound as the tire and tube flex (maintain maximum tire air pressure to further increase reliability).

USING ULTRASEAL TO REPAIR A FLAT (tubeless tire)

Ultraseal can be used as a repair method on tubeless tires. If the tire personnel inspects the damage and is assured that the wound was caused by a puncturing object that is less than 1/4" in diameter, the cords are not severely damaged, the tire has not been run flat (which causes a badly damaged inner casing with no visible outer damage) and the wound is free of any foreign substance (grease, oil, etc.), then the proper amount of Ultraseal can be installed. After installation, pull the puncturing object out and rotate the tire or drive the vehicle allowing the tire to flex. Re-air the tire to the proper air pressure. **It is important to remember that in order to check air pressure after the installation of Ultraseal, it is necessary to blow some air into the valve stem.** This will clear any Ultraseal residue that may be in the valve stem (see Maintenance Requirements section).

UNABLE TO PUSH PUMP HANDLE DOWN

Never try to force the pump handle down. If the handle will not move, make sure that the shut-off valve is in the open position or that the valve core is in fact out of the valve stem. Since the core extraction is done by "feel", it can sometimes be left only partially removed. Push the knob down and completely retighten the valve core. Be sure that the VCR is snapped onto the valve core before unscrewing the knob. Holding the knob with a firm downward action, undo the core, making sure that the clicking (back-threading) sound is felt, then let the knob and core recede into the chamber. If this procedure doesn't work, remove the VCR from the Quick Chuck. Then remove the core by hand, place a finger over the valve stem to minimize the air loss, attach the Quick Chuck directly on to the valve stem and install the proper amount of Ultraseal. Reverse the procedure to replace the core by hand (you may lose 2 to 3 lbs of air using this method). If the valve core becomes clogged, it is important to clean the Ultraseal fibers and residue off before reinstalling into the valve stem.

VALVE CORE RECOMMENDATIONS

There are two commonly used valve core styles. The most modern preferred style is the core without a visible spring. While the other contains a spring on the bottom and is regarded as the old style, the Deluxe Valve Core Remover (VCR) is designed to accommodate the short modern valve cores. The spring type cores are notorious for hanging up in the valve stem or the VCR. It is our recommendation that all valve cores used be of the short style without the visible spring.

VALVE CORE WILL NOT UNSCREW

If the valve core will not unscrew easily, then you must inspect the valve stem making sure it is round. Look at the threads to be assured that they are not damaged or clogged with mud or debris. Unscrew the core by hand to free it and clean out the threads. Once the core unscrews easily, you can then commence with installation.

AIR SOURCE REQUIREMENTS

Ultraseal will never fail to perform as claimed, providing you follow the guidelines noted throughout this installation manual. Ultraseal's formulation is designed to withstand many adversaries with one major exception, "WATER". It is imperative that the compressors be drained daily to assure that water is not introduced into the tire along with the air. Install water traps and/or air dryers. The Ultraseal formulation can tolerate a small amount of water, however, an excessive amount will break down the Thixotropic properties and render the composition useless. Some compressors blow oil; always check for this problem. Oil or grease will contaminate the formulation.

CLEARING THE VALVE CORE

After installing Ultraseal, clear the excess Ultraseal from the outer portion of the valve stem. There are several ways to effectively accomplish this. Blow air into the tire, this will clear Ultraseal from the valve stem and core, then set

tire to proper pressure. If air is not readily available, a squirt bottle can be used. Just squirt water on the end of the valve stem, this will wash out the Ultraseal that is on the outside of the valve core. Another way is to get a small sharp object (stick or wire) and a rag to wipe out the excess from the inner edge of the valve stem.

Since Ultraseal does not contain harmful or corrosive chemicals, it will not harm the valve stem or core if they are not immediately cleaned. The worst thing that can happen will be that Ultraseal will cure on the outside portion of the valve core and may prohibit adding or checking air pressure at a future date. If this happens, simply remove the valve core, rinse with water and reinsert.

CHECKING AIR PRESSURE

After the tire has been serviced with Ultraseal, it is imperative to blow a slight amount of air through the valve stem, prior to checking air pressure. The reason being, is that Ultraseal coats the inside of the valve stem and valve core, as air escapes out of the valve stem, past the valve core, Ultraseal can not differentiate between checking air pressure or a defective valve core. Ultraseal is designed to stop or hinder any escaping air. After a tire has been treated with Ultraseal, the need to have an air pressure check and inflation program is virtually eliminated. The tire inspection and pressure checking can be accomplished during the routine Preventative Maintenance program (PM). This labor saving factor alone will subsidize the installation of Ultraseal Tire Life Extender/*sealer*.

TIRE BALANCE

Ultraseal cannot cause a balance problem. Tires must be balanced prior to installing Ultraseal. It is recommended that these procedures be followed, prior to installing Ultraseal:

- Replace any unapproved outside-in repair (plugs or string repairs), then repair properly.
- Check for out-of-round rims
- Check suspension for worn and/or loose parts
- Check for out-of-round tires
- Spin balance tires

If there is an existing problem in the front suspension, wheels and/or tires that is not corrected prior to installing Ultraseal, the adverse effects may not allow Ultraseal to coat the inner surfaces of the tire/wheel thereby aggravating the situation.

There are two known tire problems that can effect Ultraseal's performance:

1. Improper repairs and string plugs, which often add excessive weight to a portion of the tire creating an adverse effect in balance, thereby causing problems with Ultraseal's ability to evenly coat the interior of the tire.
2. All tires have some sort of rib or pebble pattern on the inner liner of the tire. This pattern is a result of the blatter mold during the manufacturing process. These patterns have no function in the performance of the tire. A problem normally occurs from large ribs in a V shaped pattern and are located on the entire inner surface of the tire. If these ribs are tall enough they will prevent Ultraseal from flowing evenly within the tire. As the Ultraseal is trapped and collects in the V shaped ribs there may be enough mass to cause temporary vibrations. Large ribs have been found in only a few tires, for example a 31X10.5-15 Highway type tire on a light truck/sports utility vehicle. Check with Ultraseal's Technical Team on tires containing large V shaped ribs.

REBALANCING TIRES containing Ultraseal

The centrifugal force inside of a tire traveling at speeds over 30 mph will cause any regular tire sealant (with the exception of Ultraseal) to migrate and concentrate at the center of the tread area. This will definitely create a balance problem.

It is extremely important to understand how Ultraseal's Thixogel[®] performs (a proprietary process not found in any other tire sealant). Thixogel[®] allows Ultraseal to cling to the inner sidewalls and the entire inner surface of a properly balanced and true (round) tire/rim. The centrifugal force which is created within a high speed tire actually stretches the Ultraseal much like a rubber band, however, it will not pull the Ultraseal off the inner surface of a properly balanced tire/rim. An out of round or extremely out of balance tire/rim can create enough adverse forces to pull Ultraseal off the sidewalls.

On passenger type vehicles (where balance is critical), if a tire/rim requires in excess of 3 ounces of weight, the tire/rim should be inspected for defects and corrected prior to installing Ultraseal. Ultraseal can not correct an existing problem and may aggravate the situation.

The proper amount of Ultraseal for highway speed vehicles has been calculated to provide a complete coating to the inner surface of the tire/rim, allowing for absorption into an average casing and still maintain a reserve. The reserve (approximately 20% of the installed amount) is extra Ultraseal that will shift/move and eventually settle to the bottom of the tire after the vehicle is stopped. Each time a puncture occurs, a small amount of reserve is used and the balance of the reserve constantly redistributes as the tire rotates, thereby providing an even coating.

Any high quality speed balancer may be used to rebalance a tire containing Ultraseal. It is imperative to distribute the reserve that has settled, prior to taking a reading.

1. To distribute the reserve, mount the tire/rim onto the balance machine and start the machine to spin. It is very important, when tightening the balance machine spinner against the tire/rim, that the cone is centered, as the slightest misalignment causes an inaccurate reading.
2. Take a wooden stick (similar to a small baseball bat) or a light hammer/mallet and tap the tread area as the tire spins (the balancer's speed and short spin duration does not allow the reserve to disperse without repeated spin cycles and constant tapping).
3. To disperse the reserve thoroughly, it requires to repeat the spin cycle at least 3 times in rapid succession while tapping constantly.
4. At the completion of the third spin cycle, take a reading and place the weights as indicated. **DO NOT RE-SPIN THE TIRE**, the tire is now balanced and can be mounted on the vehicle.

Any time the balance machine is re-spun after the reserve has settled will result in an inaccurate reading and will indicate that weights are needed in different locations. This movement of the reserve is the reason you will not get a 00 reading, unless the tire/rim was in-balance initially and the reserve was properly distributed.

MAINTENANCE REQUIREMENTS

AIR PRESSURE CHECK

Once a tire has been treated with Ultraseal, frequent air pressure checks will not be necessary, although visual tire inspections are still very important. Air pressure checks can be accomplished during the routine vehicle Preventative Maintenance (PM) schedules. In order to check air pressure, remember that Ultraseal is standing on guard to prevent air loss. If you check air pressure without first blowing a slight amount of air into the valve, Ultraseal will most likely seal off the valve core. It is important to clear the valve core and stem of any Ultraseal prior to checking air pressure. **This is accomplished by simply blowing a small amount of air through the valve and into the tire, this will clear the passage and allow for proper air pressure reading.** Ultraseal will not ruin the valve core. If the core gets clogged, remove and rinse with water and reinstall (see installation tips).

TIRE INSPECTION

• TUBE TYPE TIRES

For tires that are fitted with tubes, it is recommended that a tire inspection program be instigated for high speed vehicles (over 35 m.p.h.). Tubes are notoriously unreliable, and squirm inside the tire, especially around corners. As the speed increases, a nail in the tire has the potential to rip the tube, therefore, Ultraseal will be of no help. It is always best to pull nails, rotate the tire and drive the vehicle forcing Ultraseal well into the wound. If a large object has punctured the tire and it is not losing air, leave it in, and have the tire repaired as soon as possible. Ultraseal will normally seal around a puncturing object holding the air in the tire. If the wound is dangerous, the tire will lose air pressure.

• TUBELESS TIRES

A driver should continue performing routine visual tire inspections to spot potential tire problems. Nails can be pulled, then rotate the tire or drive the vehicle. The most cost effective time for this may be during routine PM inspections.

PROBLEMS AND REMEDIES

• TIRE UNABLE TO HOLD AIR PRESSURE

ONLY AIR IS ESCAPING

This is a positive indication that there is an insufficient amount of Ultraseal in the tire, or the tire may have internal damage. Re-enter the wound with a pointed object (ice pick) and move it back and forth. As it is extracted, it will draw Ultraseal through the wound. If no Ultraseal can be drawn through the wound, then definitely there is not enough sealant in the tire to create a coating and provide a reserve. Perhaps not enough Ultraseal was initially installed or the tire has received numerous punctures or a dangerous puncture that has left an insufficient amount of Ultraseal in the tire.

AIR AND ULTRASEAL BLEEDING (Ultraseal can not mask or hide a dangerous wound)

Air and Ultraseal will bleed out of a wound, only if the wound is too large or the puncturing object has sufficiently damaged the tires inner structure, this is a potentially dangerous tire. Dismount the tire and inspect, do not plug or repair by any external method! The bleeding effect is a major proprietary function of Ultraseal, providing an unparalleled safety factor.

AIR LOSS DUE TO AIR MIGRATION

Due to the various locations of air migration, it may take more than 3 to 5 miles of driving for Ultraseal to eliminate the problem air leaks. If air migration persists, increase air pressure 10% to 15% (do not exceed maximum allowable tire pressure as recommended by the tire manufacturer) and drive vehicle approximately two days, then reduce air pressure to normal setting. By increasing air pressure, it opens the pores and forces Ultraseal into the problem area, eliminating air migration.

SIDEWALL PUNCTURE

Ultraseal's warranty is for the tread area of the tire only. The tread area has sufficient rubber and plies for adequate flexing and recovery. Sidewall construction is extremely thin, especially in radial tires. Ultraseal is capable of providing minor repairs to the sidewall/crown areas. But due to vast variance in tire manufacturing and subsequent wounds that may severely damage the tires structural integrity, Ultraseal does not consider sidewall/crown repairs as positive repairs.

MAJOR DAMAGE

If a tire serviced with Ultraseal receives major damage, it can not hold air pressure. Ultraseal is designed to slowly release air pressure, providing a safety factor that is not found in any tire. Regardless of how small or how large the wound may be, Ultraseal can not mask or hide a dangerous wound. Depending on the severity of the wound, Ultraseal and air will bleed, until all of the air and Ultraseal have been exhausted. This safety feature assists the driver in executing a controlled and safe stop. Ultraseal is used in emergency and law enforcement vehicles primarily for safety.

• UNABLE TO ADD AIR TO THE TIRE

VALVE CORE BLOCKAGE

If air will not go into the tire, check the valve core, it may be clogged. This will occur if air pressure was checked without first clearing the Ultraseal from the valve stem, or if there is a defective valve core (see installation tips). If the core is known to be in good condition, then simply rinse it with water and reinstall. It may be more cost effective to replace a valve core.

• HOW TO REPAIR A TIRE CONTAINING ULTRASEAL

TUBELESS TIRES

Dismount the tire and wipe the Ultraseal away from the damaged area with a damp rag, dry the area that is to be repaired, buff and repair as normal. If the repairs (including mounting and dismounting) are completed within 2 hours, it is not necessary to remove the remaining Ultraseal from the tire. Remount and add any additional Ultraseal that may have been lost through the wound or that was removed to perform the repair.

TUBE TYPE TIRES

Tubes can be easily repaired. Ultraseal will not cause a problem, simply spread the tube over an anvil or other work area. Move the Ultraseal away from the damaged area by applying finger pressure on the tube and pressing away from the damage, thereby forcing the Ultraseal away from the wound. Wipe the area with a damp rag, dry thoroughly and repair as normal. We recommend using a hot patch. If you do use cold patches, be aware that some adhesives are effected by Ethylene Glycol (a chemical used in the Ultraseal formulation). This type of adhesive is not common, however it is not compatible. To check for compatibility, rub Ultraseal on a dry sample of the adhesive. If the adhesive does not soften or dissolve, then there should not be any adverse reaction. Make sure after repairing the tube to replace any Ultraseal that has been lost. We recommend that radial tubes be used due to their superiority (see installation tips).

RETREADING TIRES CONTAINING ULTRASEAL

PREPARING THE TIRE FOR RETREADING

Vacuum the Ultraseal out of the casing and dispose of as per MSDS requirements, then wipe the tire with a damp rag (plain water), wipe dry. Ultraseal leaves no residue. Leave puncturing objects in for the inspector to pull out and mark for repair. All punctures that have been previously sealed and repaired by Ultraseal are considered a positive/secure repair and require no special attention; however, at the discretion of the inspector the Ultraseal repair can be removed without any problem and a standard repair can be performed. If the tire has been left open and the Ultraseal has cured, it can be removed with an air hose, simply blow air into the tire. Ultraseal has no adhesive characteristics.

TIRE INSPECTION

The retread inspector should repair all wounds that have not been repaired by Ultraseal, no special repair procedure is necessary. Wounds that have been repaired by Ultraseal may not show up on NDI equipment or other such diagnostic equipment, but will show up as a small clot of fibers protruding from the inner casing, which is not necessary to disturb unless an additional repair is required or the retreader wishes to do a repair. The Ultraseal that is embedded in the wound is fully compatible with all retread methods and will assist in providing a sound casing to enhance the retread.

RETREAD COMPATIBILITY

All components of the Ultraseal formulation have been tested and are fully compatible with all tire compositions and retreading methods. Since Ultraseal International, Inc.'s inception in 1969, actual in-field use in the real world and countless retreaded casings have provided sufficient data to ensure that Ultraseal does not have a compatibility problem. For the very best results, we recommend that Ultraseal be installed into a newly retreaded tire prior to the first full air inflation. Air the tire to approximately 20 lbs. and rotate, allowing the Ultraseal to coat the inner surface of the tire casing. The air pressure will force Ultraseal into any missed nail holes, improper repairs, damaged Ultraseal repair/clots and imperfections that may be in the casing. Then continue to re-air the tire to its proper air pressure. After the tire is removed from the cage it should be rotated, allowing the Ultraseal to continue coating and eliminating any additional imperfections opened by the additional air pressure. Once the tire is installed onto the vehicle, the weight of the vehicle and heat generated from rolling friction, plus the flexing of the tire will force Ultraseal deep into the casing, sealing the entire casing from migrating air.

**OVERINFLATION****UNDERINFLATION****PROPER INFLATION****OVERINFLATION leads to:**

- (1) increased tendency toward bruises and impact breaks.
- (2) more cuts and snags.
- (3) rapid wear in the center portion of the tread.
- (4) excessive strain on bead and rim.
- (5) abnormal tire growth, stretching of tread and tread cracking.
- (6) abnormal stresses and strains in the tread, leading to tread separation.
- (7) harder riding, reduced cushioning and increased equipment maintenance costs.
- (8) reduced traction and skid resistance.

UNDERINFLATION leads to:

- (1) excessive heat, causes ply separation.
- (2) tread separation.
- (3) irregular tread wear.
- (4) premature tire failure.

PROPER INFLATION

It's the air that carries the load, not the tire. When tires are inflated to the recommended air pressures, the cord body is able to do its job of flexing without injury. When tires are either overinflated or underinflated, satisfactory service cannot be obtained. Premature tire failure is eminent.

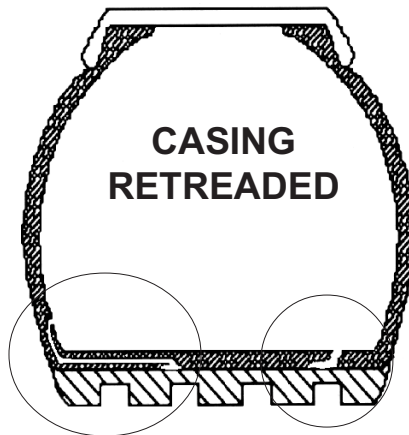
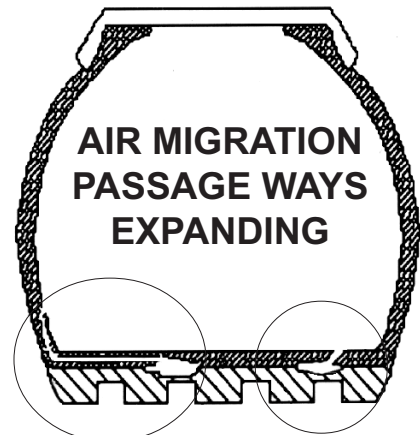
**TIRE CASING
WITH
AIR MIGRATION****CASING
RETTREADED****AIR MIGRATION
PASSAGE WAYS
EXPANDING**

Air migration in a tire casing is a malignant problem and to some extent is present in all tires. Once established, the passages ways will intensify premature tire failure on any new or retreaded tire.

The majority of premature tire failure, in both new and retreaded tires is a result of improper air pressure maintenance. Underinflation creates excessive heat, delamination, tread separations, blowouts and Zipper ruptures. Every time the tire is driven underinflated the hidden internal damage increases. The damage accumulates until the tire eventually disintegrates. The constant resetting of air pressure is merely a bandage and does not cure the malignant problem. To cure the problem one must eliminate the source, the only known and proven way to eliminate porosity and air migration is to install Ultraseal Tire Life Extender/sealer.